

M3 in pietra ollare

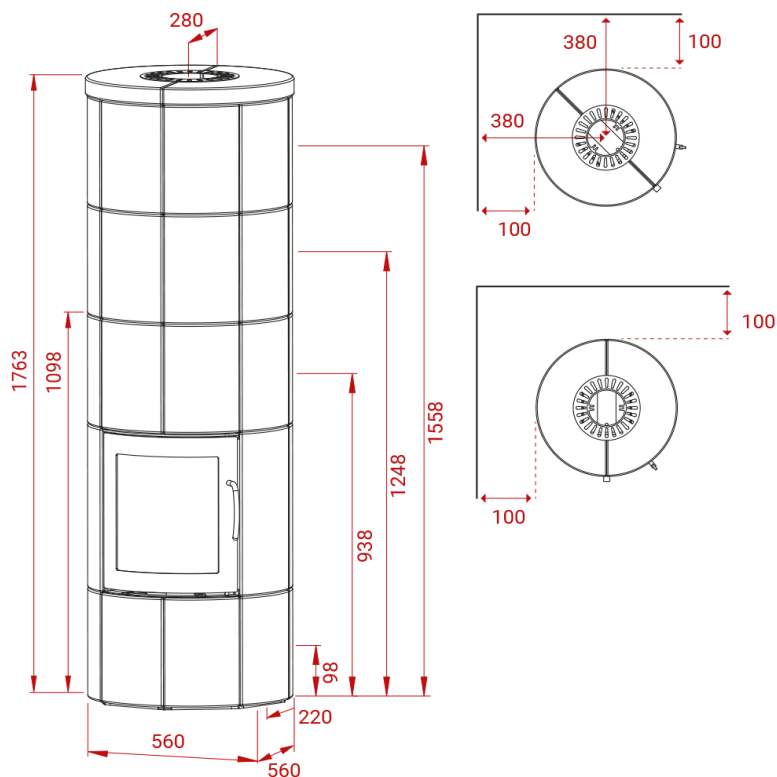

Peso 655 kg



Area riscaldata
30-120 mq



Depressione fumi
12 Pa



Polveri sottili
24 mg/m³



Potenza nominale
6 kW



Consumo orario
1,8 kg



Potenza di esercizio
4-10 kW



Rendimento
82%