

PRIO 6S – rivestimento ollare o Indian Night

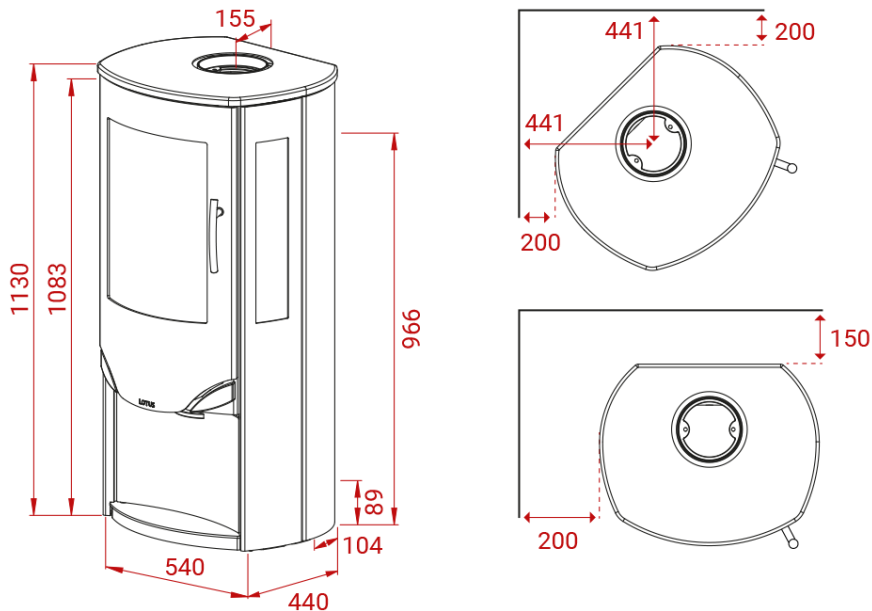

Peso 226 kg



Area riscaldata
30-120 mq



Depressione fumi
12 Pa



Polveri sottili
28 mg/m³



Potenza nominale
7 kW



Consumo orario
2,1 kg



Potenza di esercizio
3-8 kW



Rendimento
79%