

## M3 Indian Night

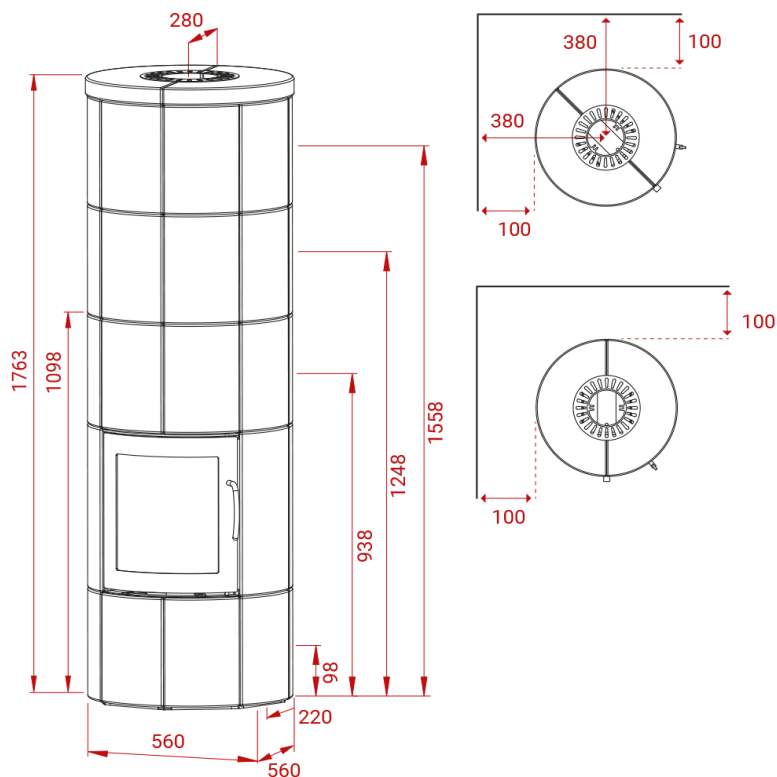

Peso 655 kg



Area riscaldata  
30-120 mq



Depressione fumi  
12 Pa



Polveri sottili  
24 mg/m<sup>3</sup>



Potenza nominale  
6 kW



Consumo orario  
1,8 kg



Potenza di esercizio  
4-10 kW



Rendimento  
82%