

BETO 700M in ollare

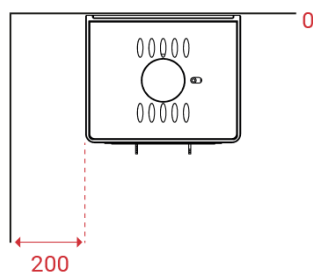

Peso 495 kg

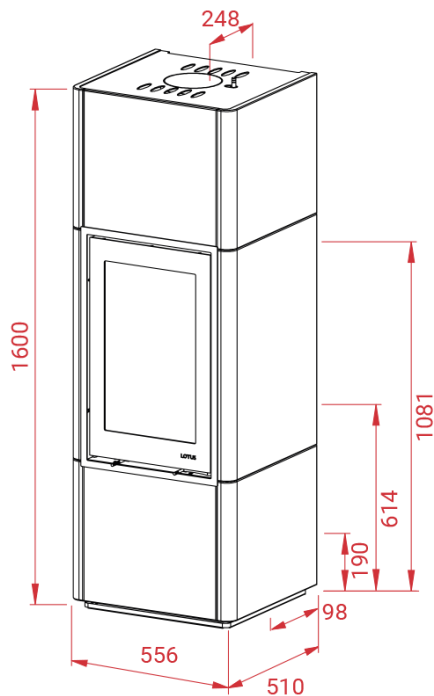

Area riscaldata
30-120 mq



Depressione fumi
12 Pa



Polveri sottili
29 mg/m³



Potenza nominale
5 kW



Consumo orario
1,7 kg



Potenza di esercizio
3-7 kW



Rendimento
83%