

INSERTO UNICO 11

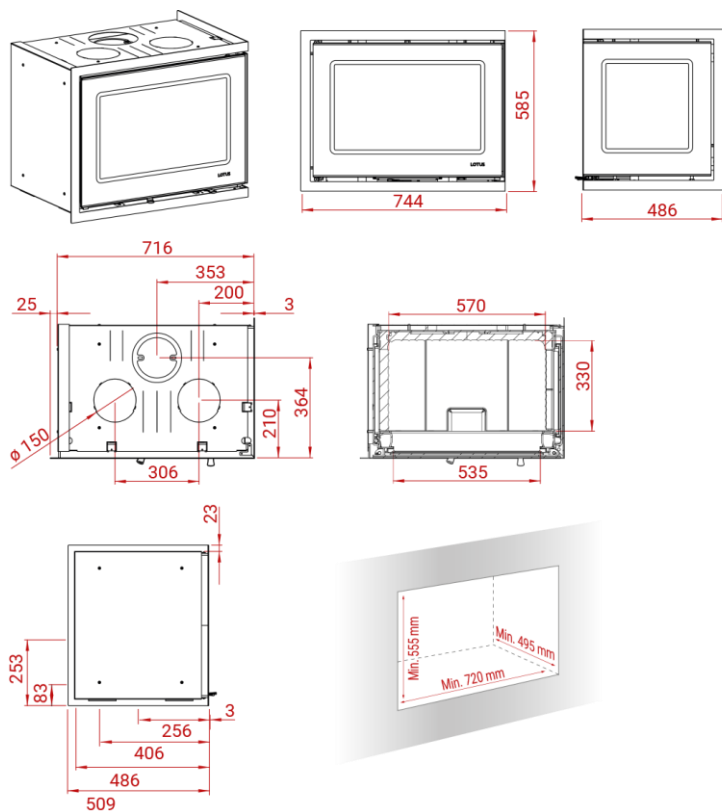

Peso 122 kg



Area riscaldata
30-150 mq



Depressione fumi
12 Pa



Polveri sottili
33 mg/m³



Potenza nominale
6 kW



Consumo orario
1,8 kg



Potenza di esercizio
4-9 kW



Rendimento
80%