

INSERTO H370

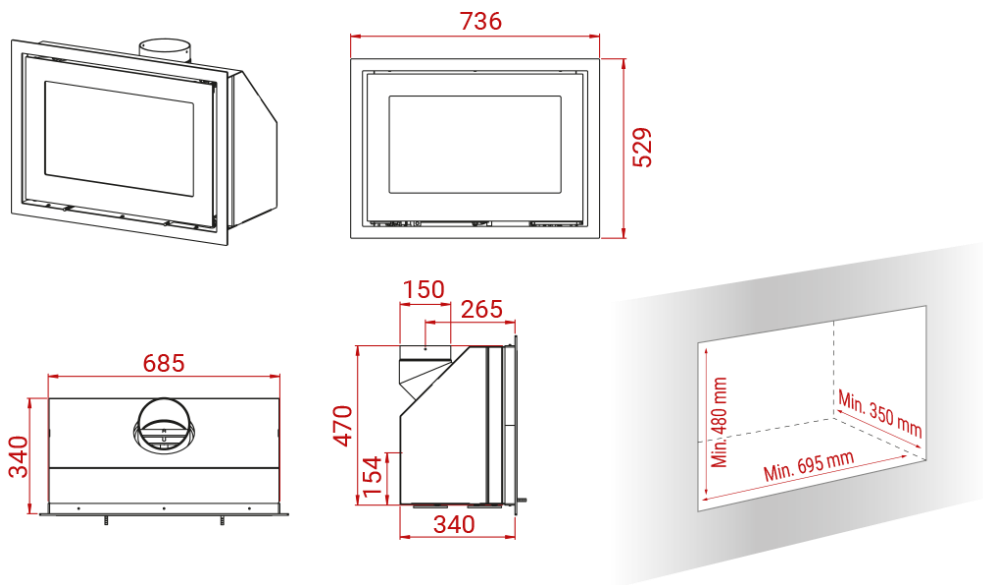

Peso 87 kg



Area riscaldata
30-110 mq



Depressione fumi
12 Pa



Polveri sottili
23 mg/m³



Potenza nominale
6 kW



Consumo orario
1,5 kg



Potenza di esercizio
3-7 kW



Rendimento
78%