

INSERTO H700

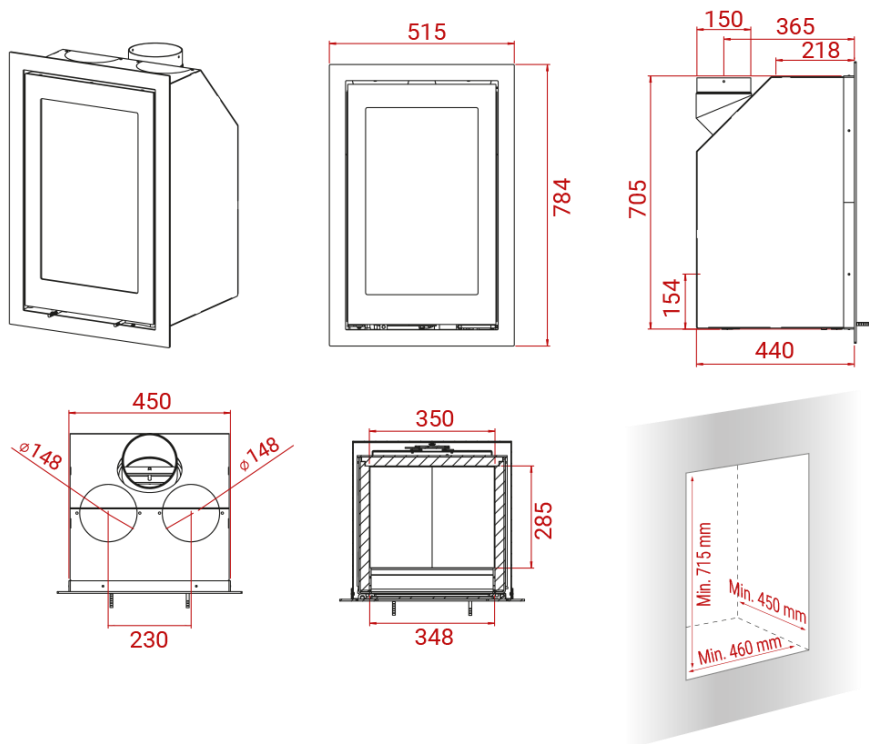

Peso 96 kg



Area riscaldata
30-120 mq



Depressione fumi
12 Pa



Polveri sottili
29 mg/m³



Potenza nominale
6 kW



Consumo orario
1,7 kg



Potenza di esercizio
3-7 kW



Rendimento
83%