

INSERTO H470 AIR

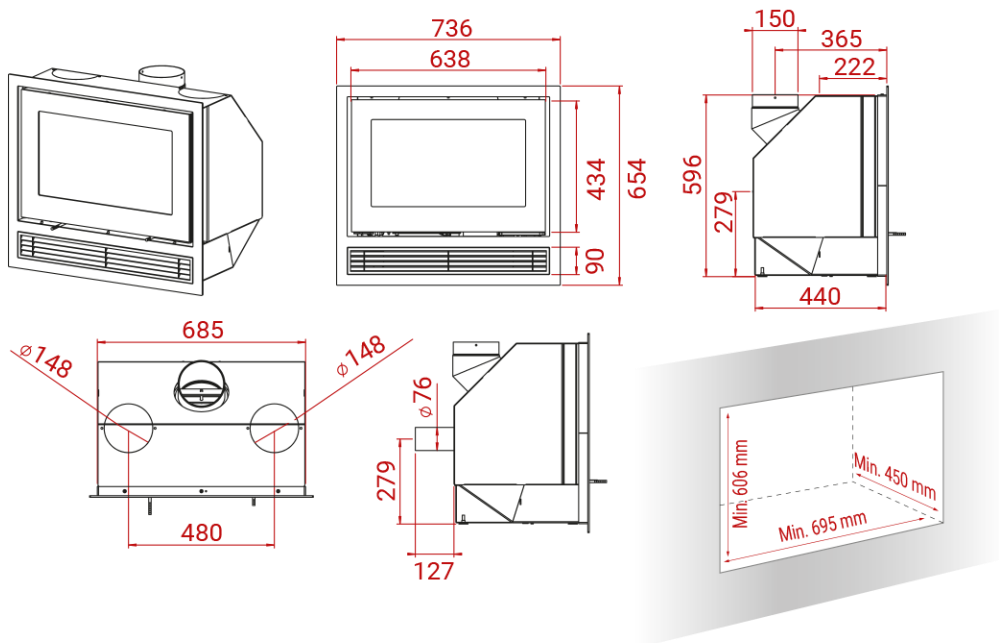

Peso 107 kg



Area riscaldata
40-140 mq



Depressione fumi
12 Pa



Polveri sottili
18 mg/m³



Potenza nominale
6 kW



Consumo orario
1,7 kg



Potenza di esercizio
3-9 kW



Rendimento
84%