

INSERTO H470W AIR

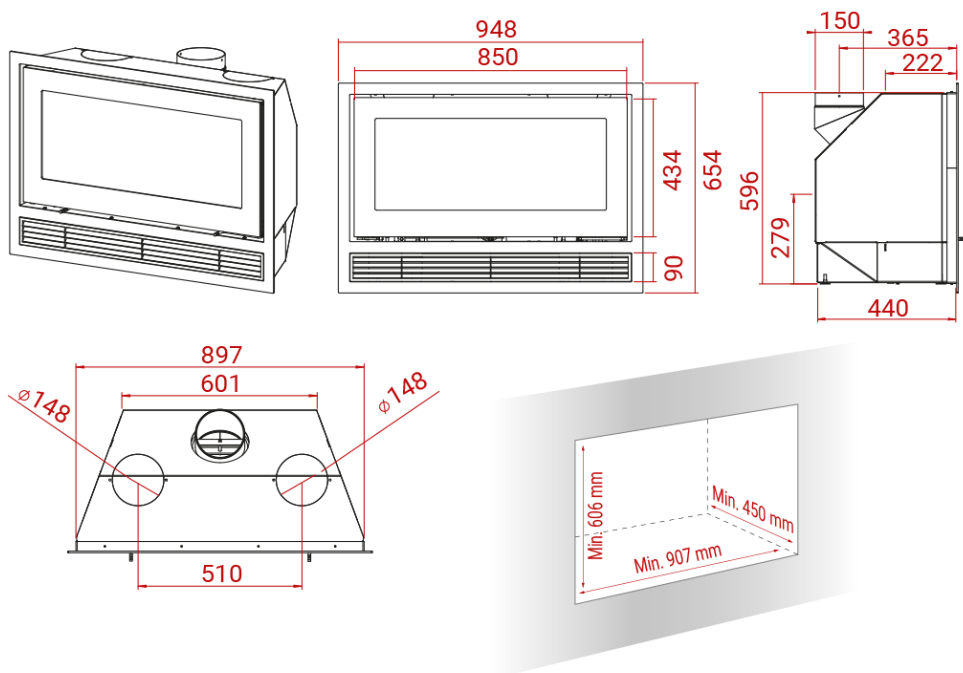

Peso 135 kg



Area riscaldata
40-190 mq



Depressione fumi
12 Pa



Polveri sottili
19 mg/m³



Potenza nominale
7 kW



Consumo orario
2/2,5 kg



Potenza di esercizio
3-10 kW



Rendimento
80,5%