

LIVA 8G

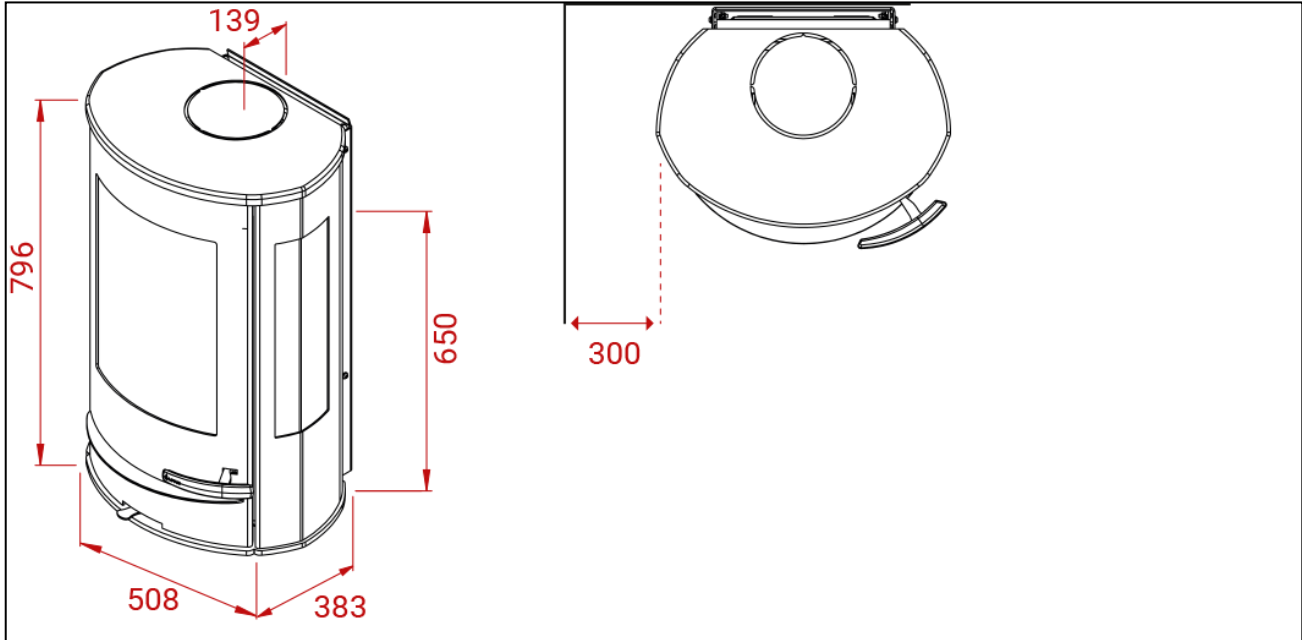

Peso
116 kg



Area riscaldata
30-120 m²



Depressione fumi
12 Pa

Mg/M³

Polveri sottili
27



Potenza nominale
5 kW



Consumo orario
1,7 kg



Potenza di esercizio
3-7 kW



Rendimento
78%