

2080/2280

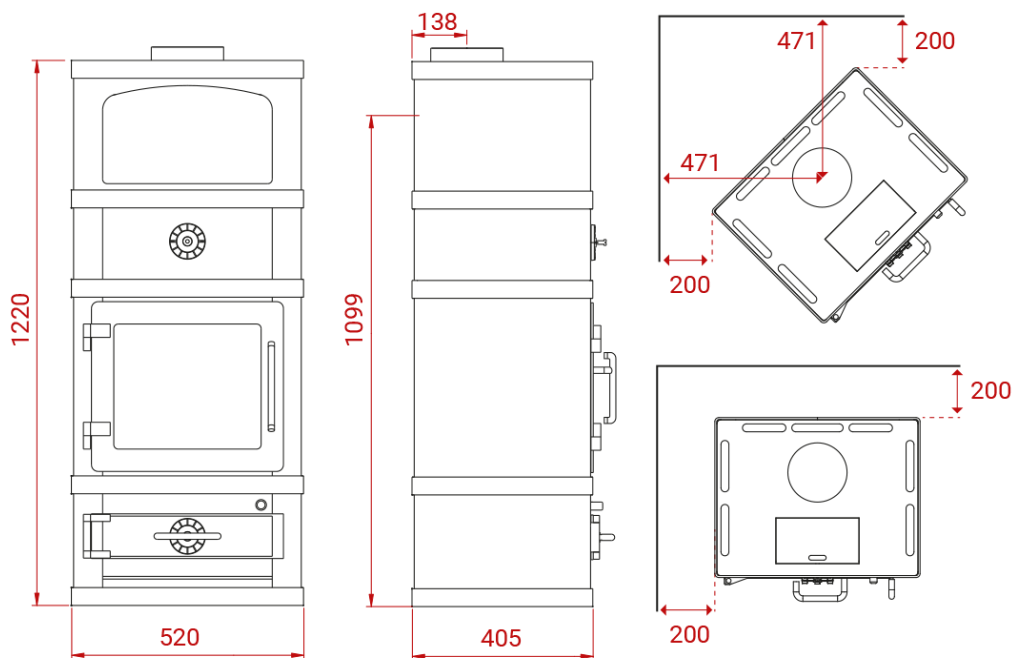

Peso 347 kg



Area riscaldata
30-160 mq



Depressione fumi
12 Pa



Polveri sottili 37
mg/m³



Potenza nominale
8 kW



Consumo orario
2,4 kg



Potenza di esercizio
3-10 kW



Rendimento
84%