

9230 – rivestimento in ollare

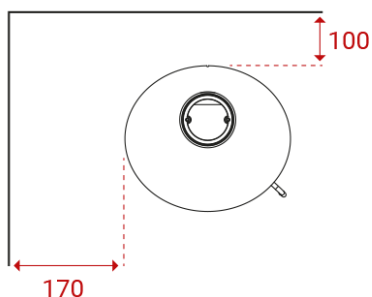

Peso 176 kg

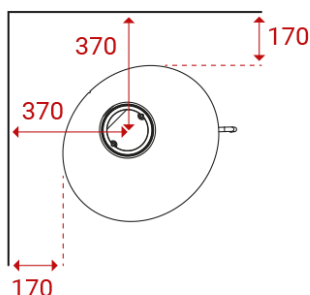
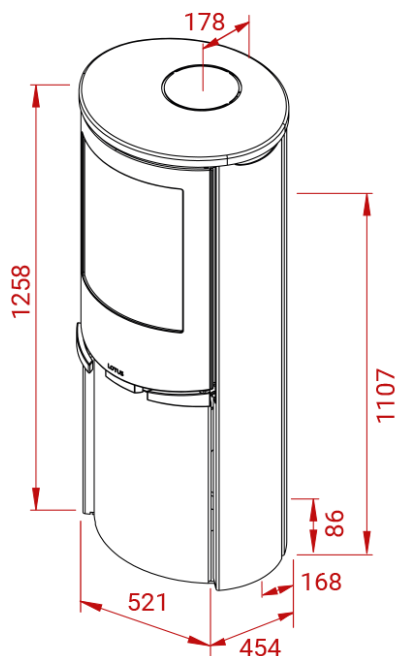

Area riscaldata
30-120 mq



Depressione fumi
12 Pa



Polveri sottili 22
mg/m³



Potenza nominale
5 kW



Consumo orario
1,7 kg



Potenza di esercizio
3- 7kW



Rendimento
81%